

H-180タイプ

正面図 S=1/20

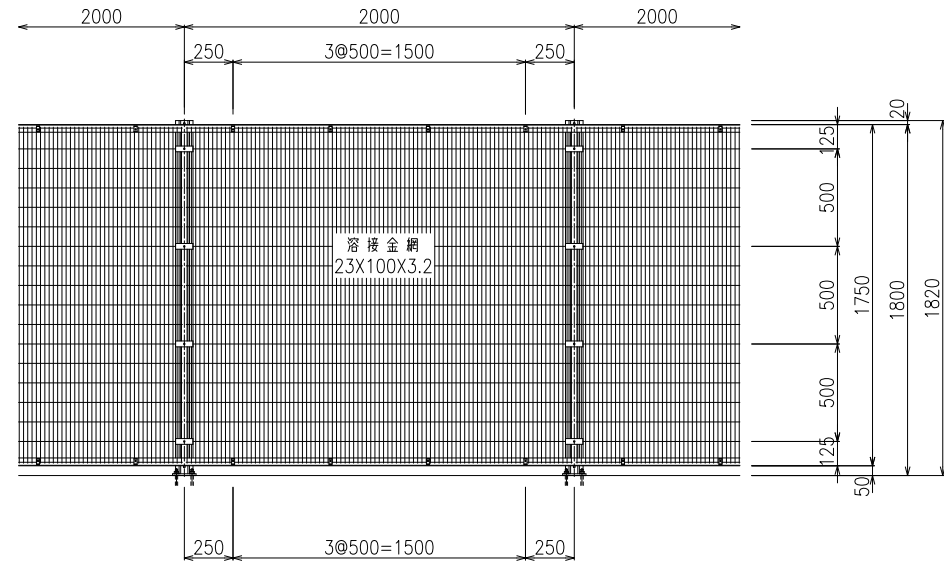

断面図 S=1/20

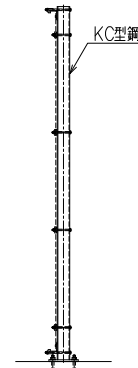

H-140タイプ

正面図 S=1/20

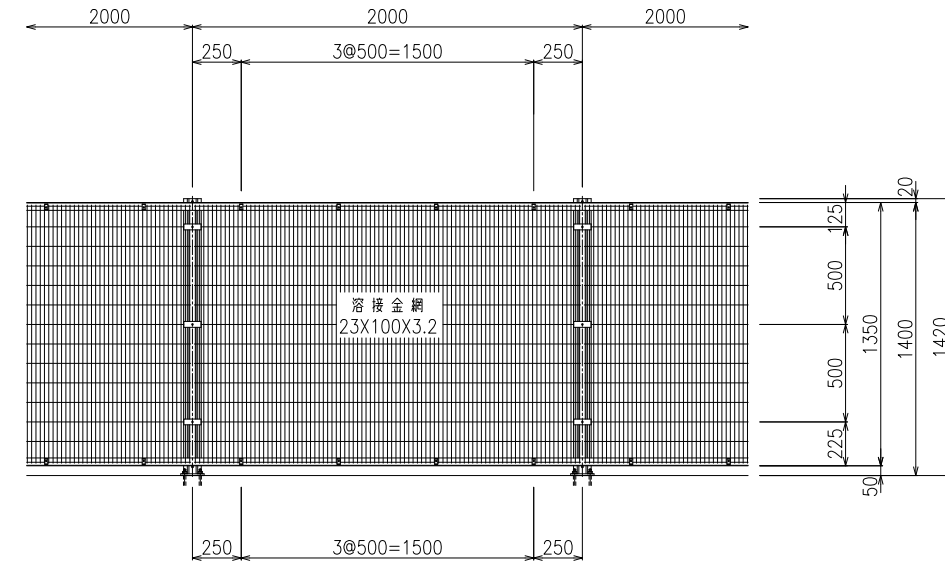

断面図 S=1/20

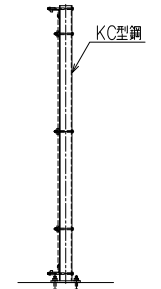

主柱胴縁取付部 S=1/4

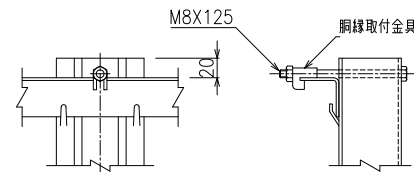

取付金具詳細図 S=1/2

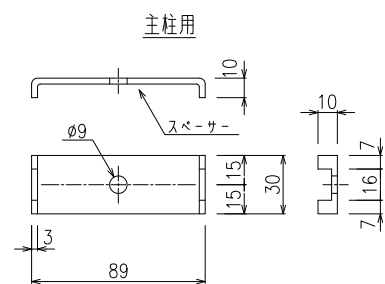

主柱用

メッシュ取付部 S=1/6

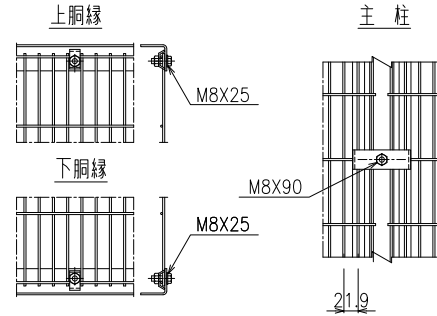

胴縁用

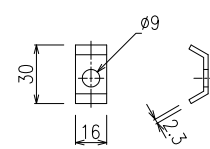

胴縁取付金具 S=1/1

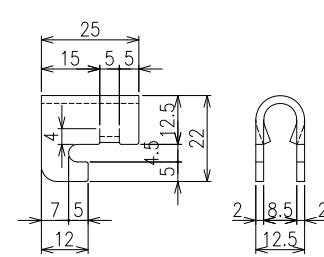

主柱 S=1/2

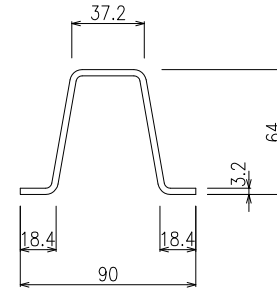

胴縁継手部 S=1/6

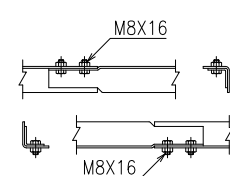

胴縁詳細図 S=1/6

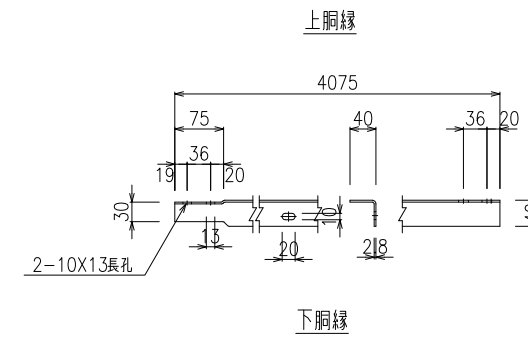

下胴縁

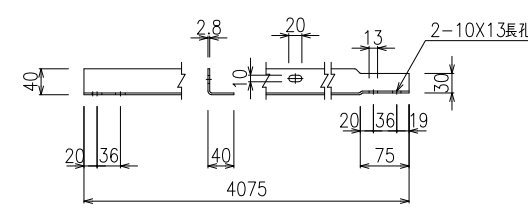

基礎部取付詳細図 S=1/4

