

片開き門扉
(H-120・W-102)

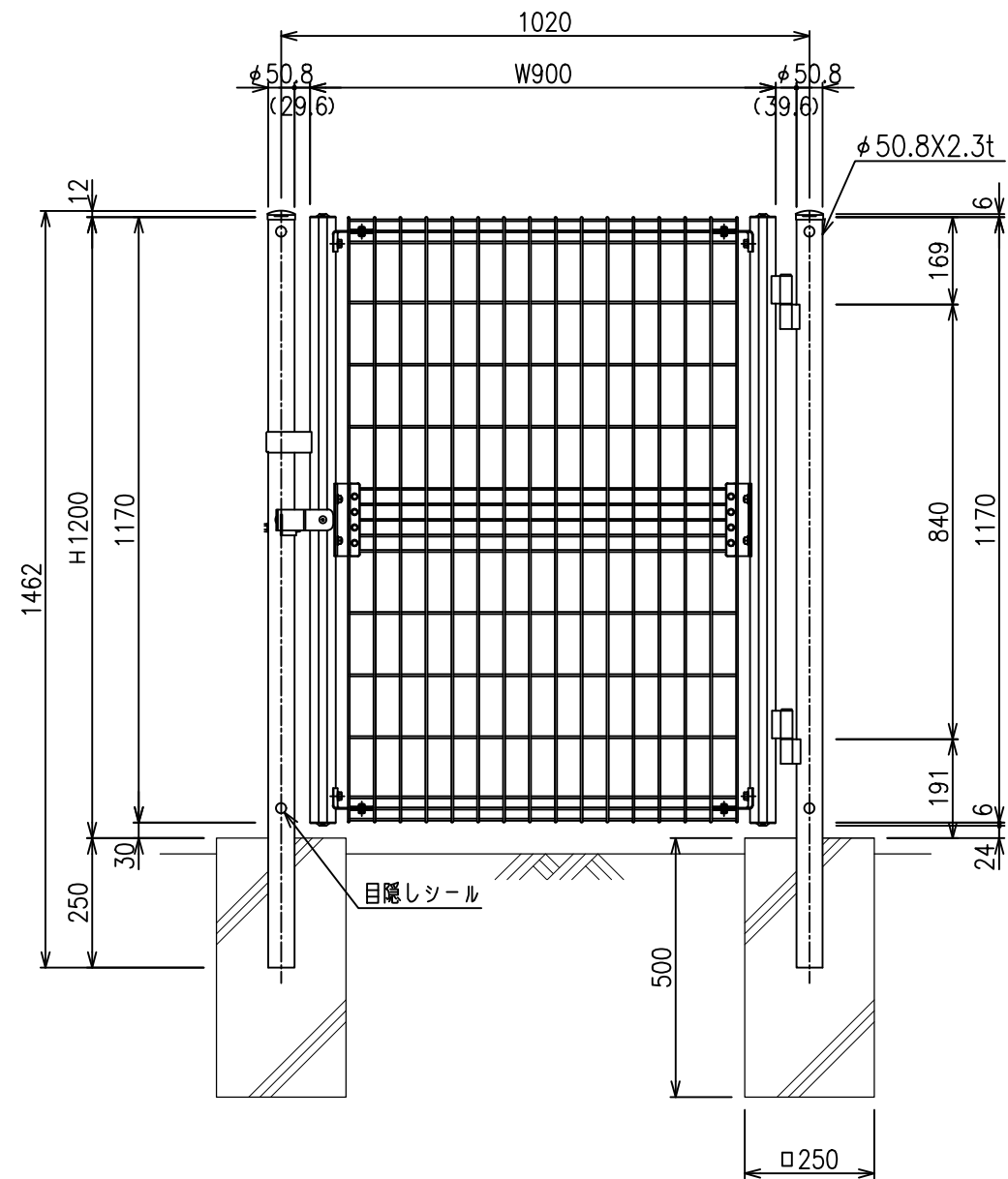

打掛錠部詳細

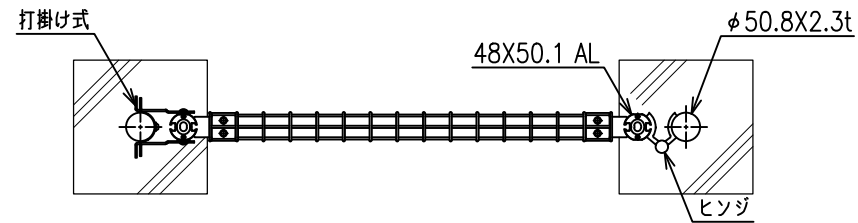
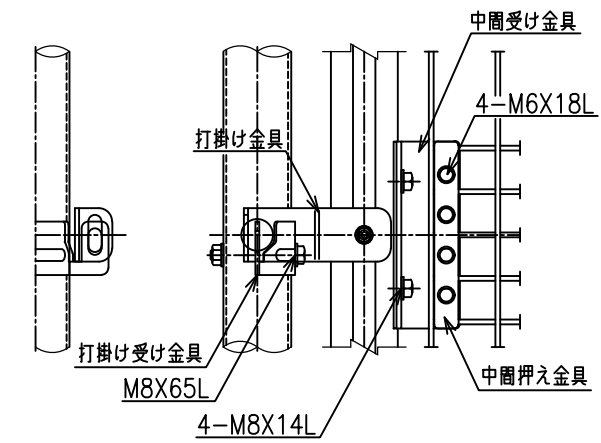
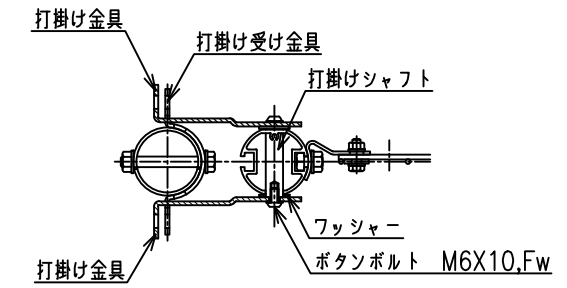

	外径	芯径	塗装
縦線・横線	φ4.2	φ4.0	静電粉体塗装