

両開き門扉
(H-100・W-196)

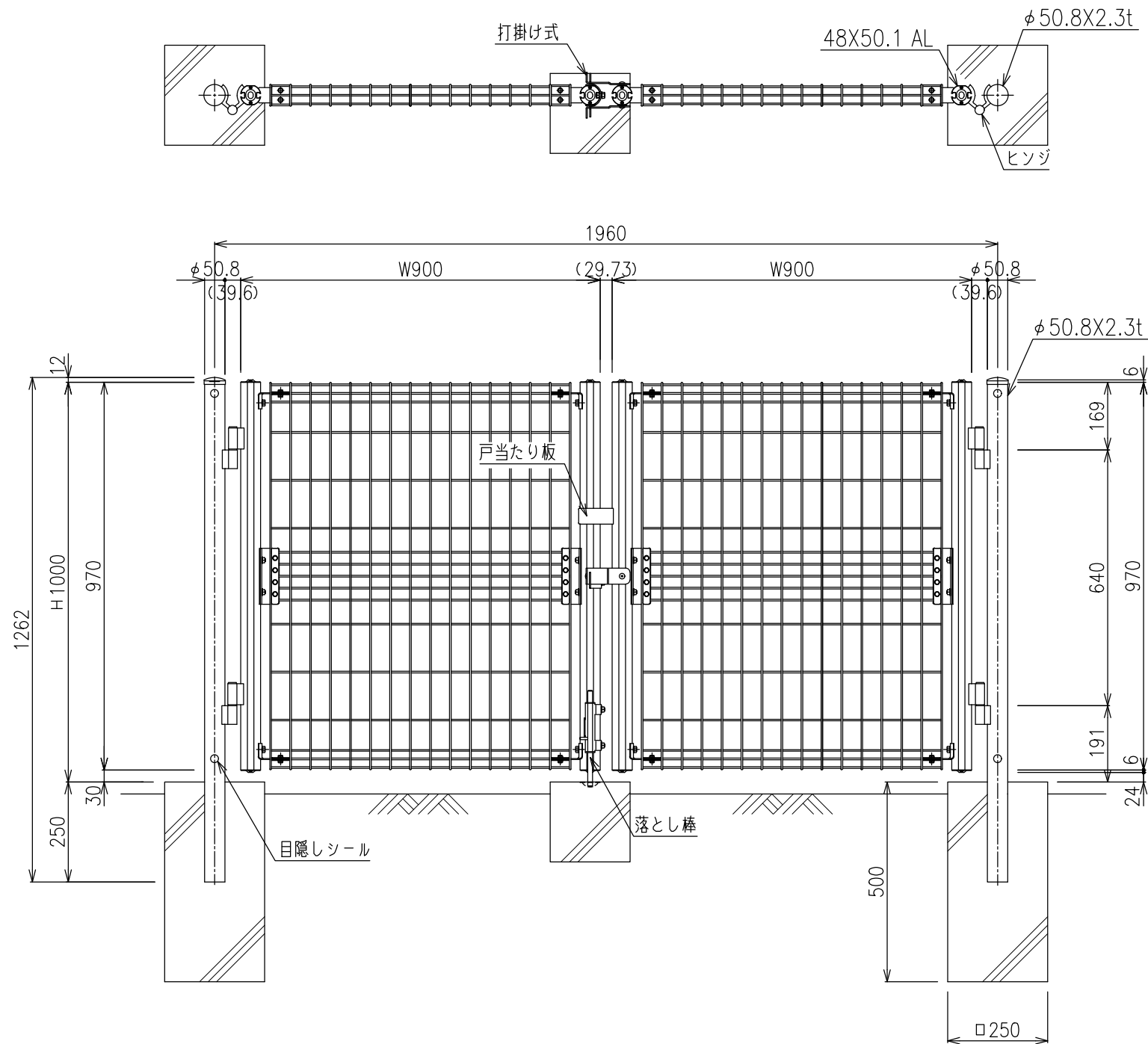

両開打掛部詳細図

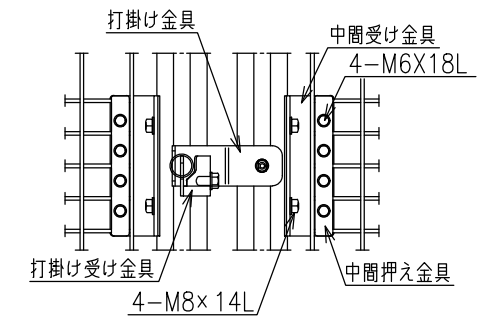
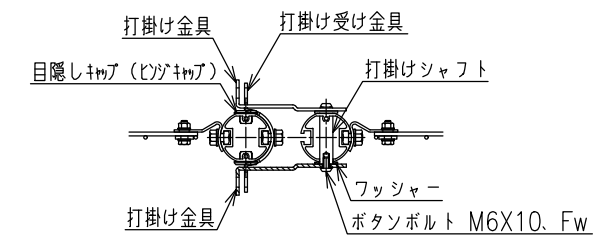

落とし棒詳細図

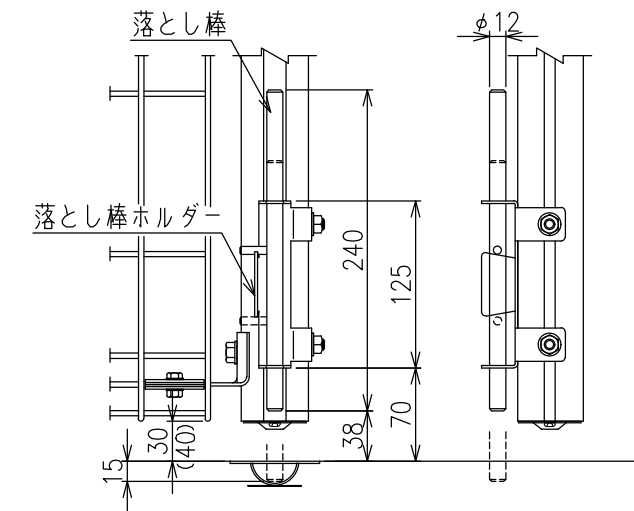

	外径	芯径	塗装
縦線・横線	φ4.2	φ4.0	静電粉体塗装