

フェンス 組立図

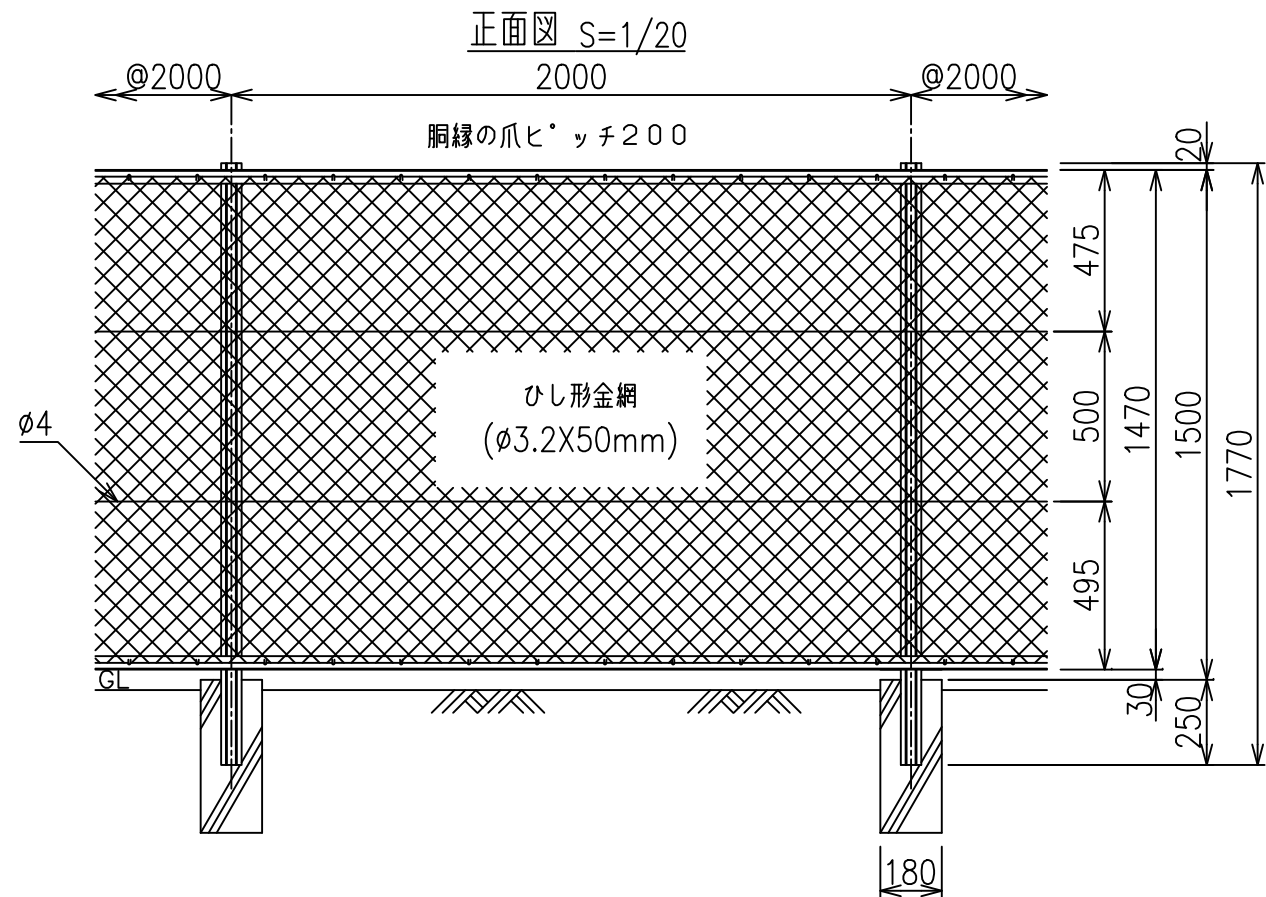

側面図 S=1/20

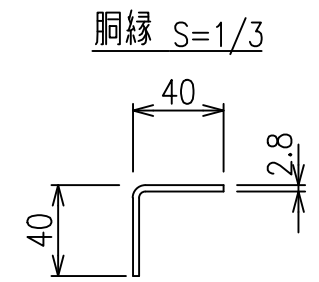
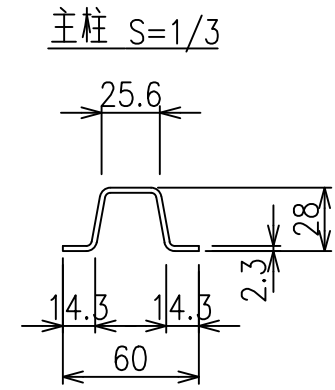
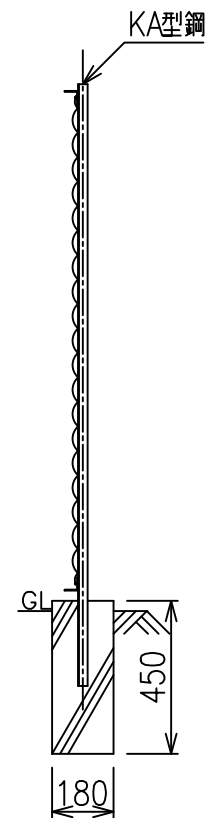

コーナー柱と胴縁取付部 S=1/5

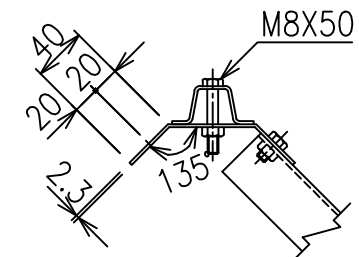

主柱胴縁取付部 S=1/6

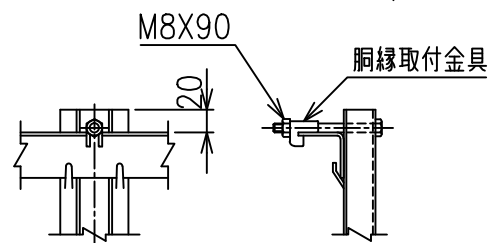

金網取付部 S=1/5

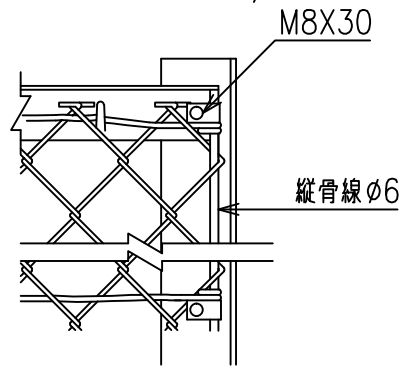

端柱断面図 S=1/3

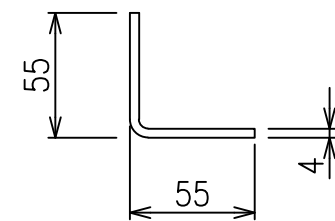

主柱骨線取付部 S=1/6

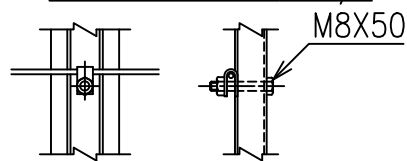

胴縁 S=1/6

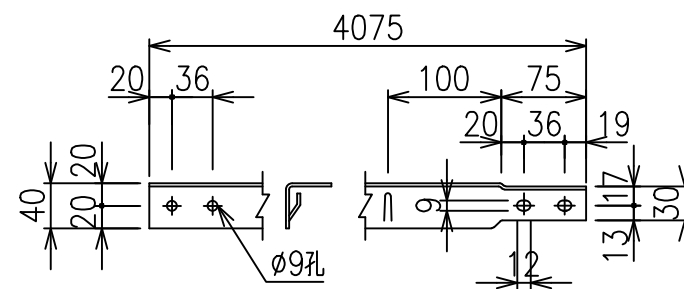

胴縁継手部 S=1/6

