

フェンス 組立図

正面図 S=1/20

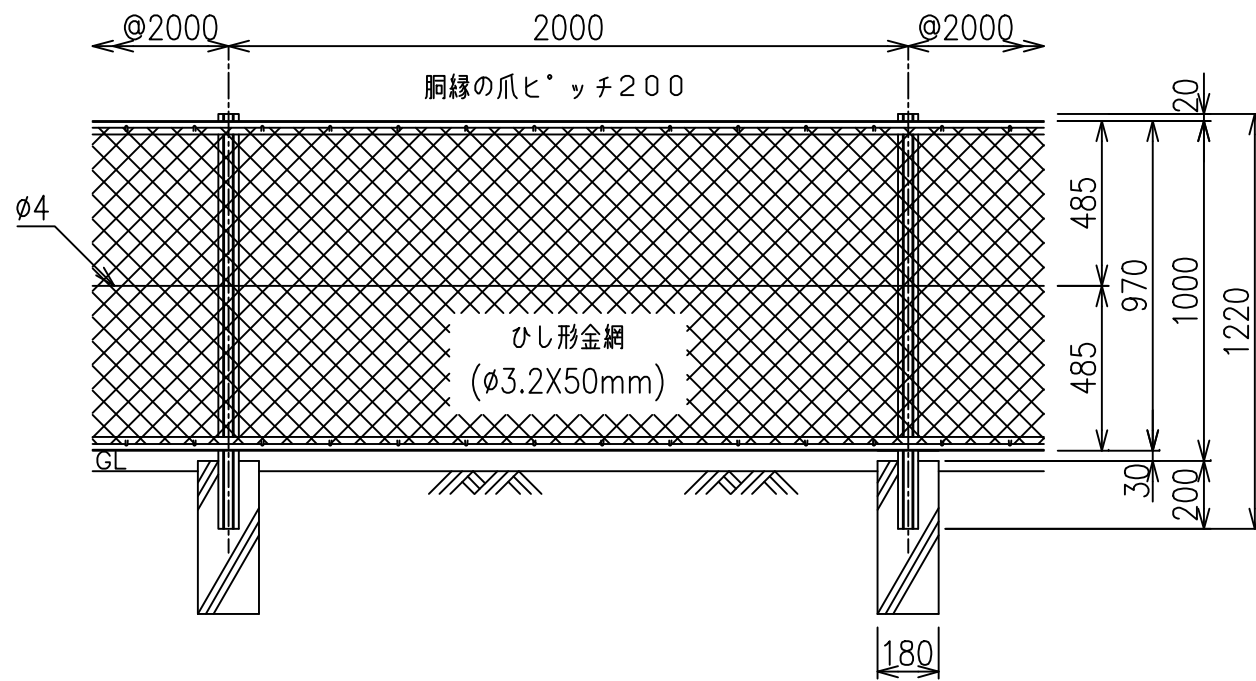

側面図 S=1/20

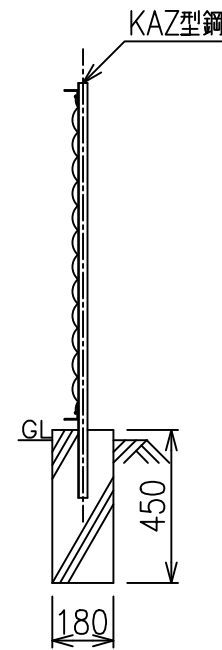

主柱 S=1/3

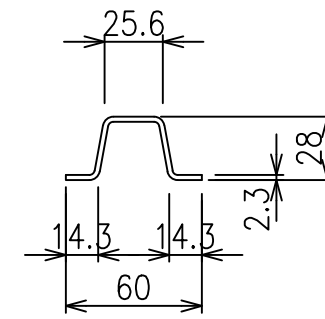

網縁 S=1/3

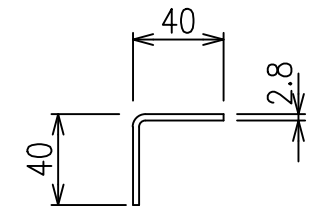

主柱網縁取付部 S=1/6

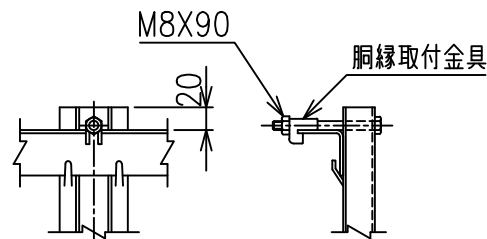

金網取付部 S=1/5

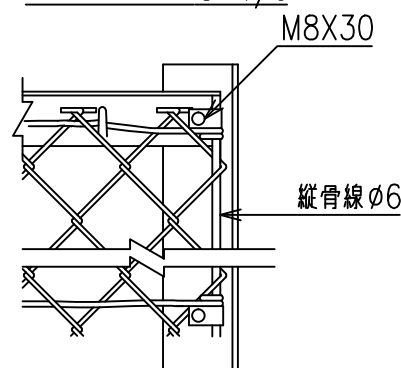

端柱断面図 S=1/3

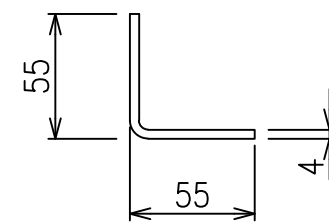

コーナー柱と網縁取付部 S=1/5

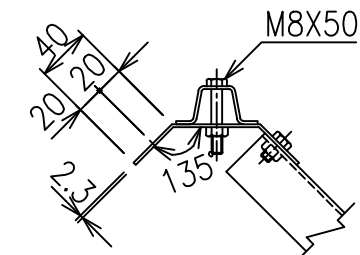

主柱骨線取付部 S=1/6

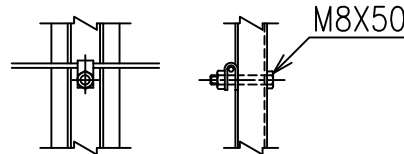

網縁 S=1/6

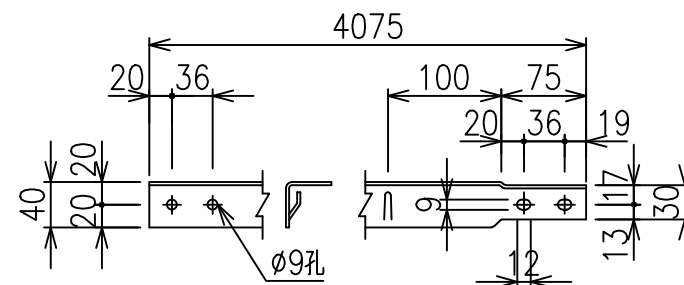

網縁継手部 S=1/6

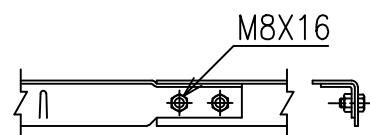

*出力する用紙サイズにより、表示された縮尺とは異なる場合があります。