

フェンス 組立図

正面図 S=1/30

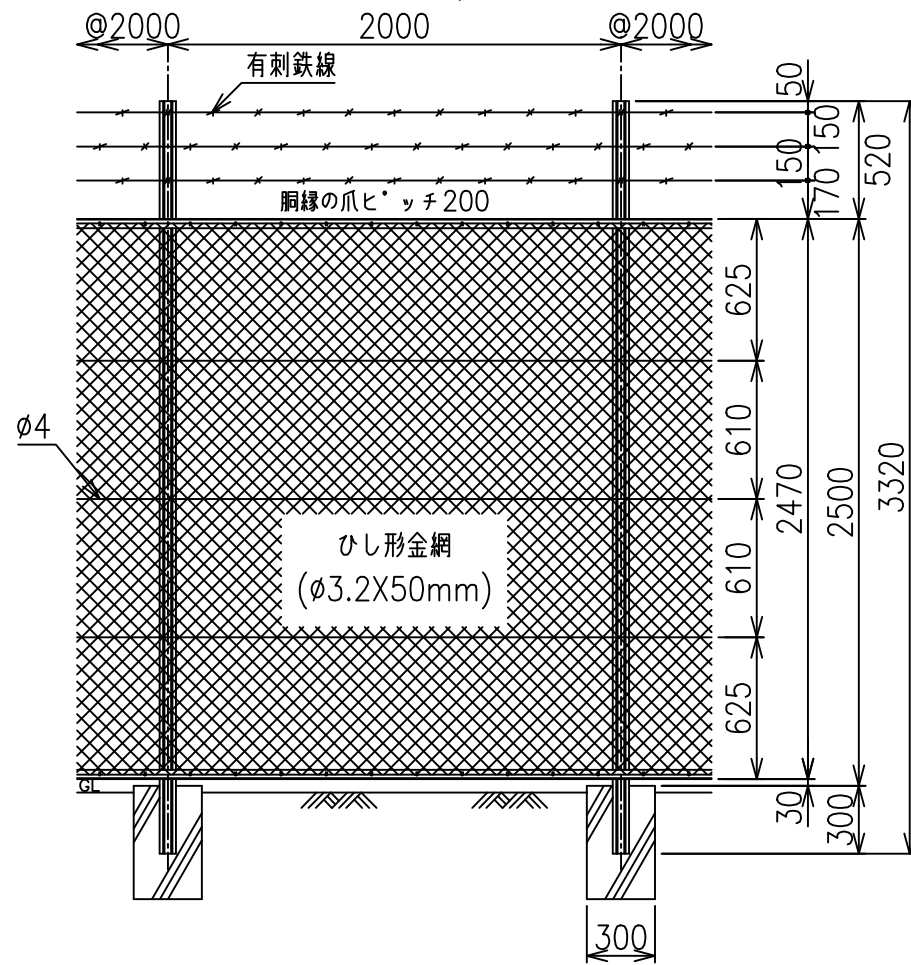

側面図 S=1/30

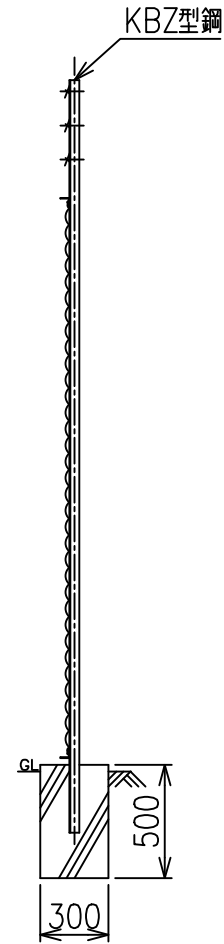

主柱 S=1/3

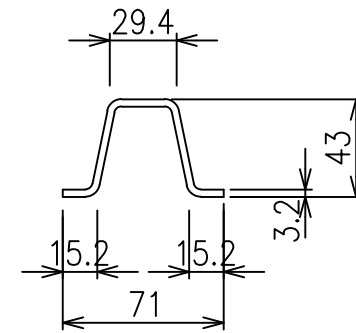

胴縁 S=1/3

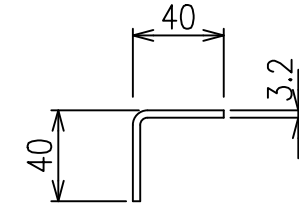

端柱断面図 S=1/3

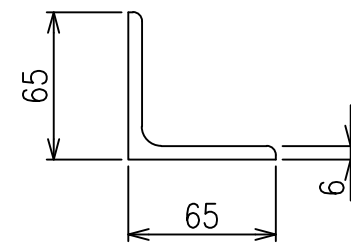

コーナー柱と胴縁取付部 S=1/5

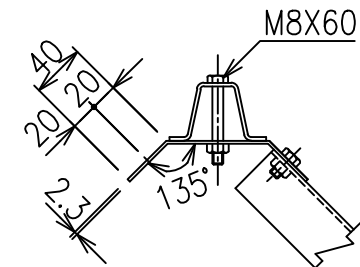

金網取付部 S=1/5

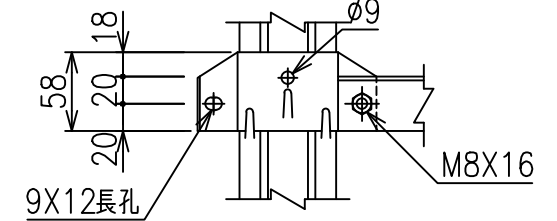
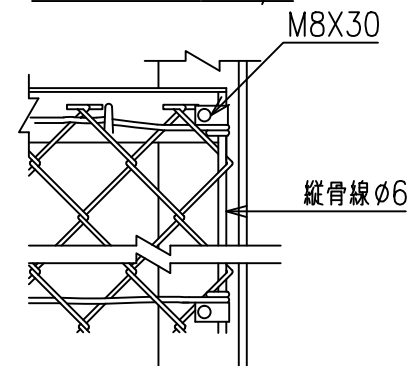

主柱胴縁取付部 S=1/6

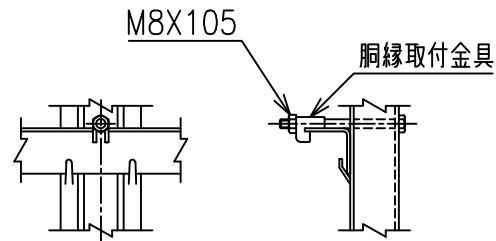

主柱骨線取付部 S=1/6

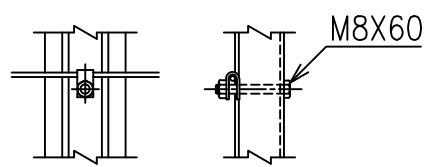

胴縁 S=1/6

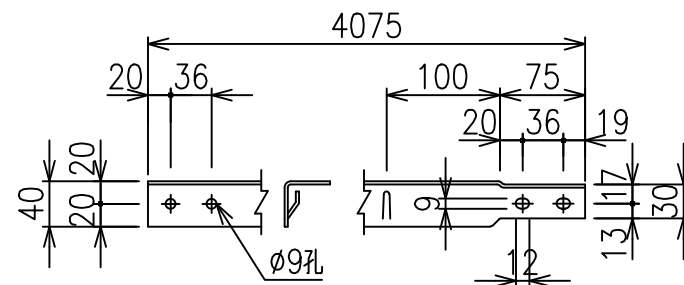

胴縁継手部 S=1/6

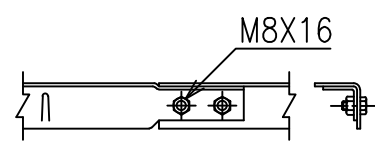

*出力する用紙サイズにより、表示された縮尺とは異なる場合があります。