

S3(2)部材表 5スパン当り

名称	規格	長さ	数量	材質	備考
1 主柱	φ60.5X3.2	1680	5	STK-400	HDZ-55
2 上綱線	φ42.7X2.3	3000	3	STK-400	HDZ-40
3 下綱線	φ34.0X2.3	3000	3	STK-400	HDZ-40
4 ひし形金網	φ3.2X56m/m	1.33 m	9.96 m <sup>2</sup>	SWMGS-7(Z-GS7)	
5 継骨棒	φ4	7500	4	SWMGS-7	
6 鋼管杭	φ139.8X3.5	1400	5	STK-400	HDZ-55

S3(2)門扉部材表 1扉当り

名称	規格	長さ	数量	材質	備考
1 門柱(用り元側)	φ60.5X3.2	1680	1	STK-400	HDZ-55
2 門柱(施設側)	φ60.5X3.2	1680	1	STK-400	HDZ-55
3 門枠	φ34.0X2.3	4559	1	STK-400	HDZ-40
4 帯板	PL-100X4.5	788	1	SS-400	HDZ-40
5 プレース	φ13	1445	2	SS-400	HDZ-35
6 ひし形金網	φ3.2X56m/m		1 m <sup>2</sup>	SWMGS-7(Z-GS7)	
7 鋼管杭	φ139.8X3.5	1400	2	STK-400	HDZ-55

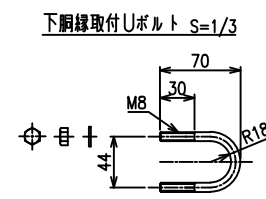
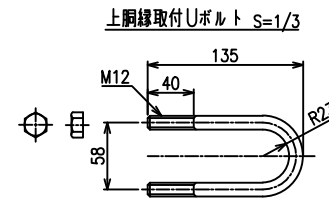
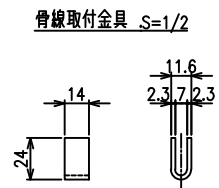
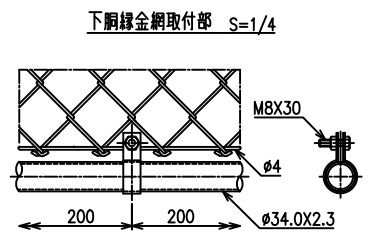
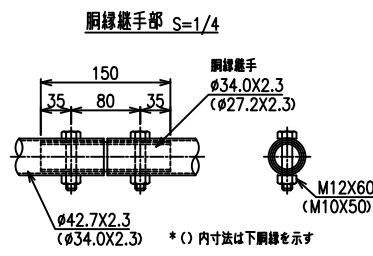
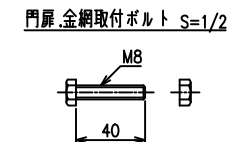
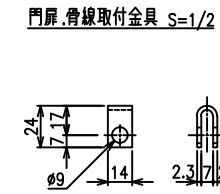
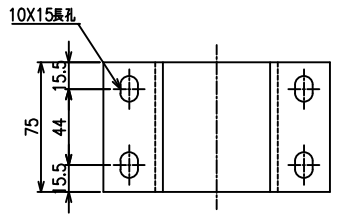
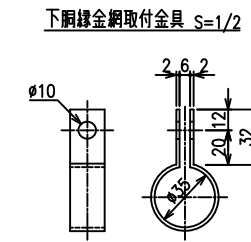
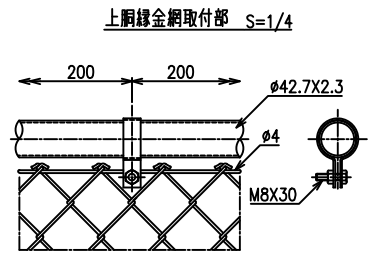
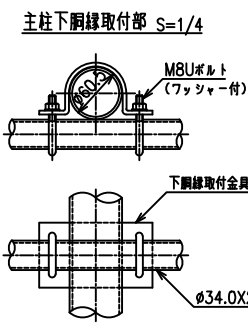
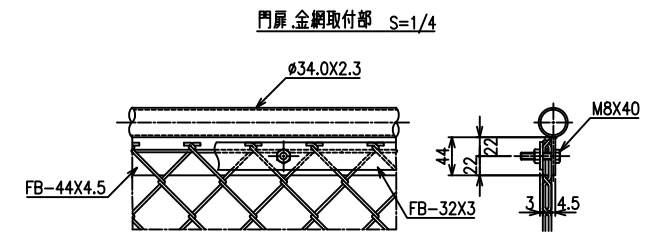
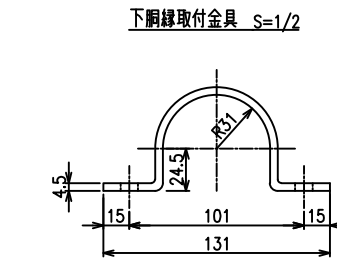
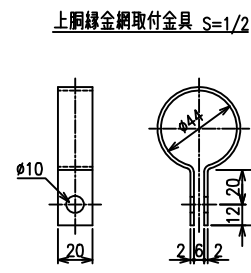
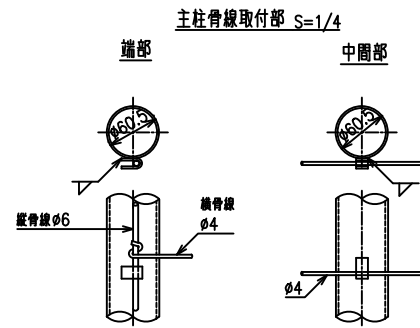
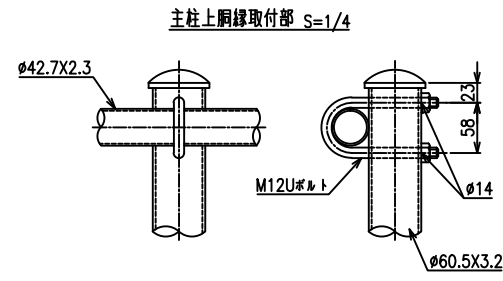

\*柱にはめっきの為、湯抜き孔を適所(見苦しくない位置)に設けます。  
\*出力する用紙サイズにより、表示された縮尺とは異なる場合があります。