

主柱胴縁取付部 S=1/6

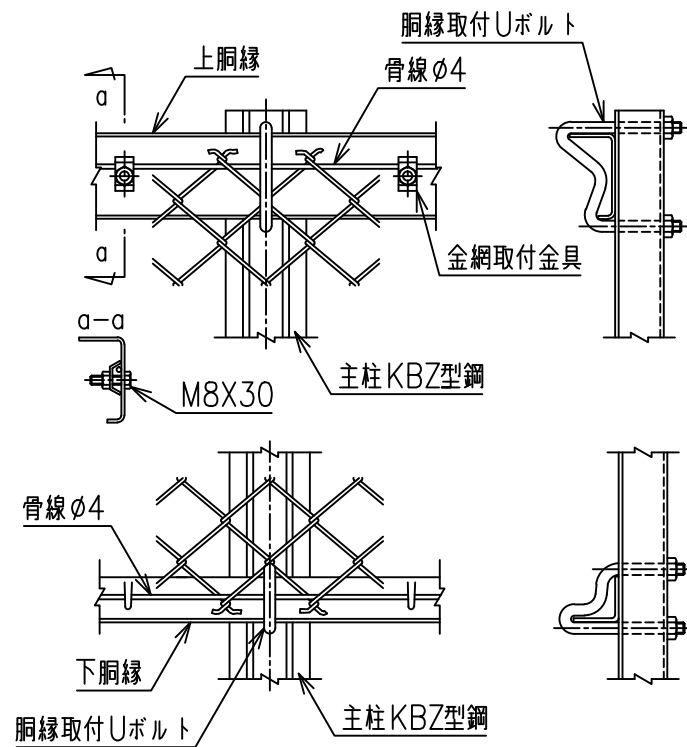

主柱骨線取付部 S=1/6

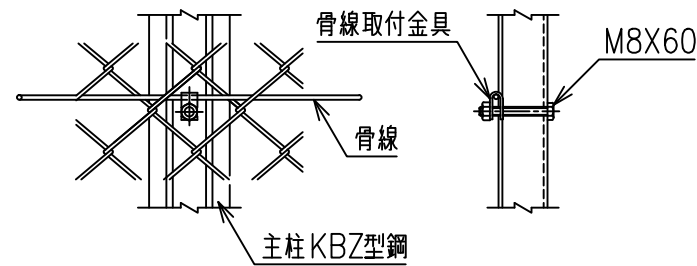

隅柱取付部 S=1/6

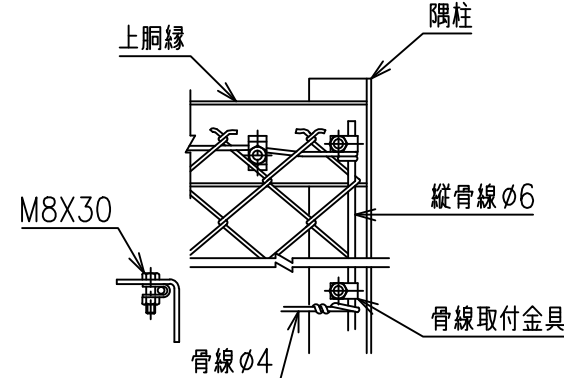

金網取付金具 S=1/2

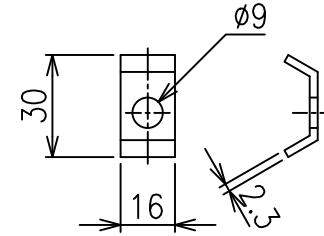

胴縁取付Uボルト S=1/5

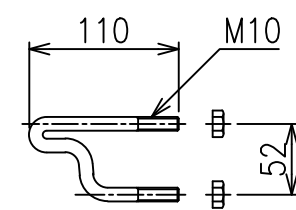

骨線取付金具 S=1/2

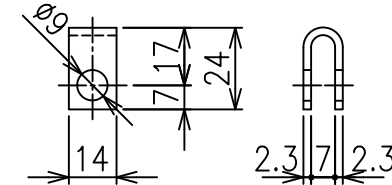

ボルト・ナット S=1/5

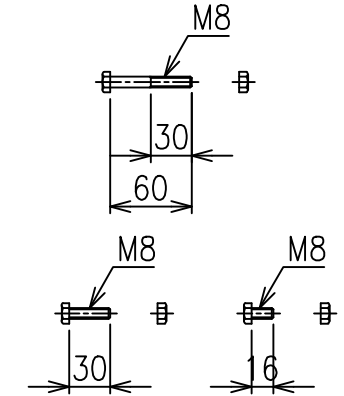

\*出力する用紙サイズにより、表示された縮尺とは異なる場合があります。