

脱着式S・P基礎(φ89.1支柱用)

全体図 S=1/10

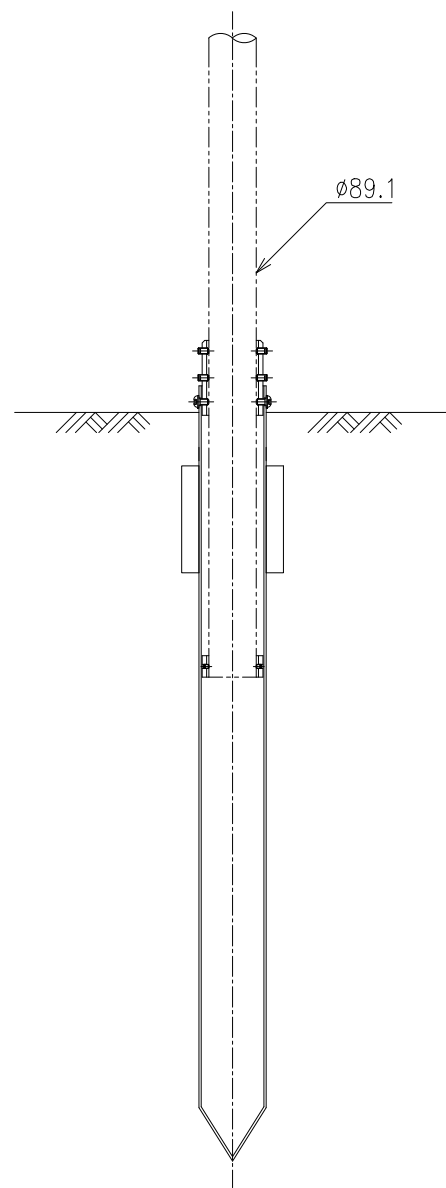

取付詳細図 S=1/6

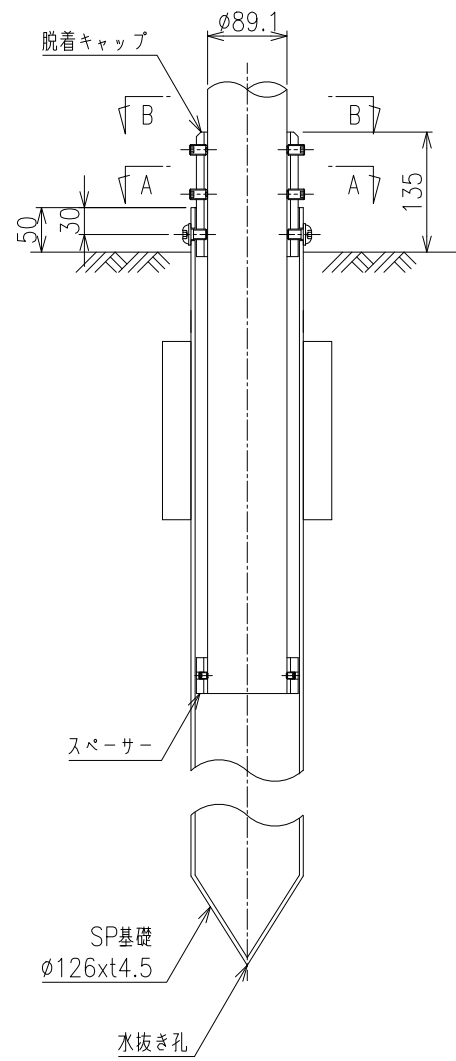

A-A詳細 S=1/3

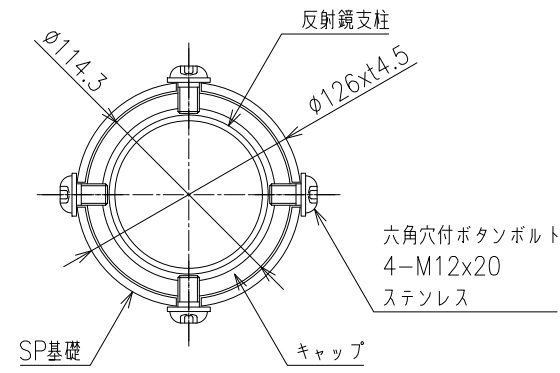

脱着式キャップ S=1/6 (φ89.1支柱用)

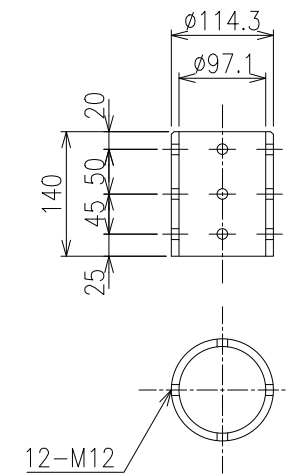

S・P基礎 S=1/5

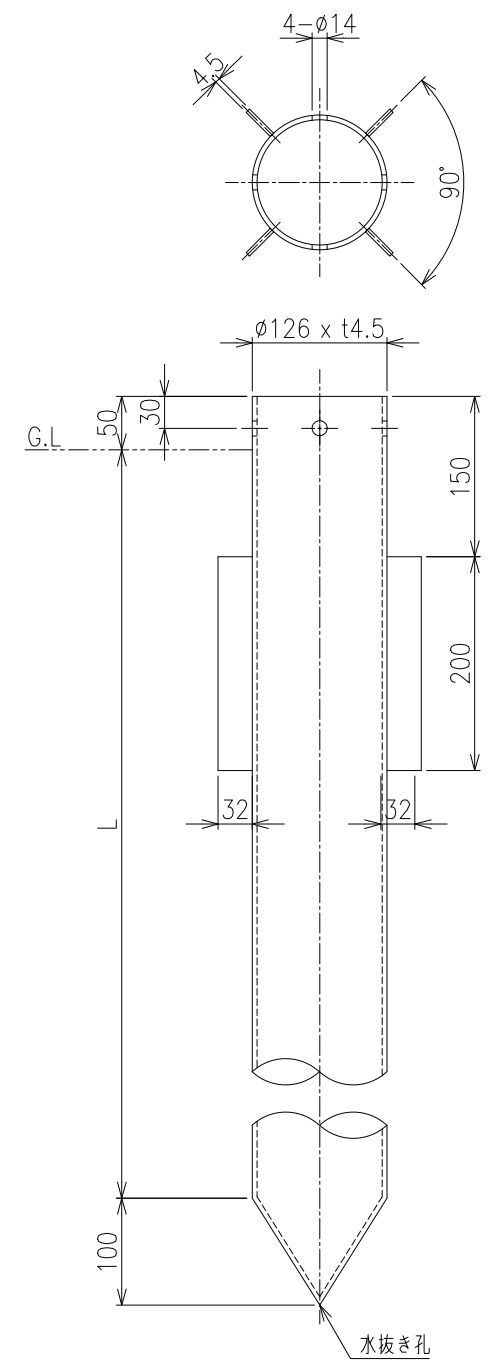

B-B詳細 S=1/3

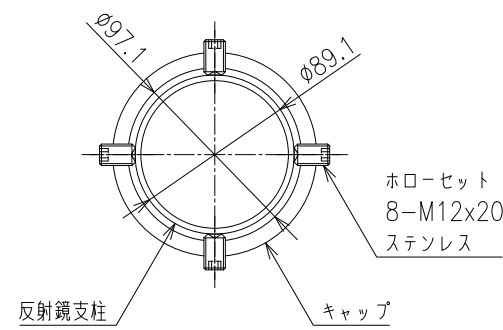

スペーサー S=1/6 (φ89.1支柱用)

