

脱着式S・P基礎(φ76.3支柱用)

全体図 s=1/10

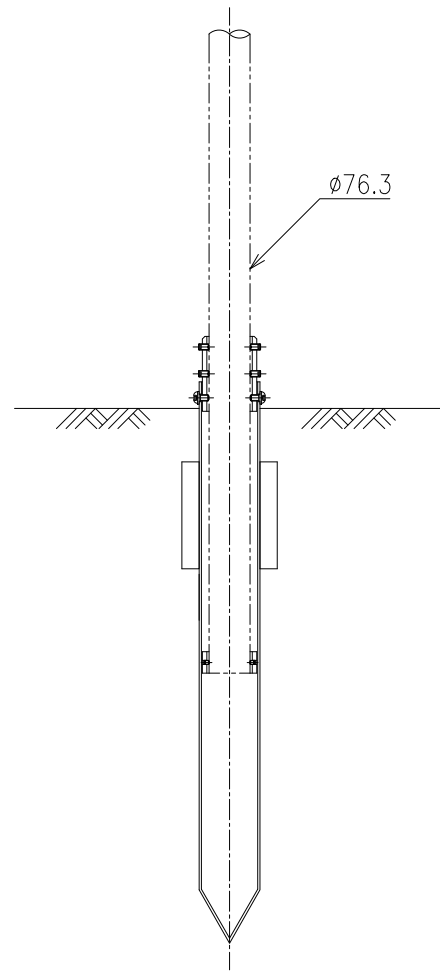

取付詳細図 s=1/6

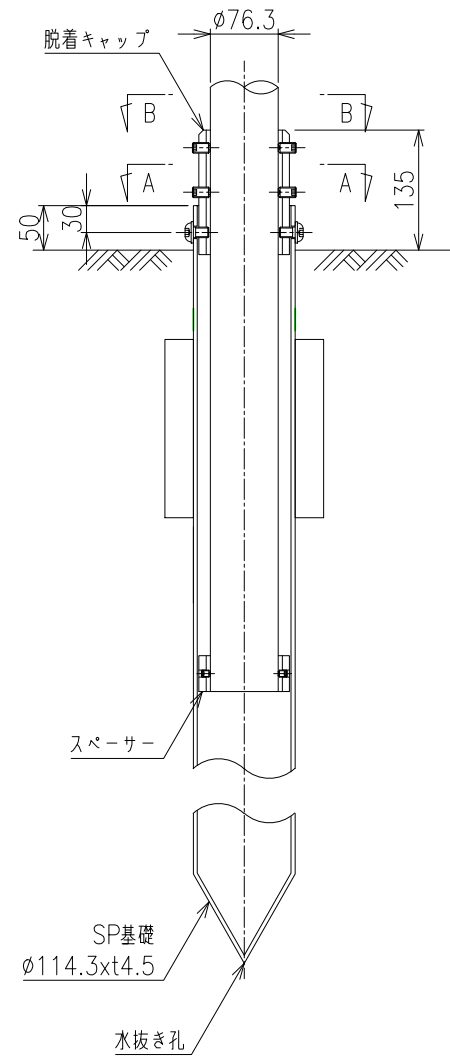

A-A詳細 s=1/3

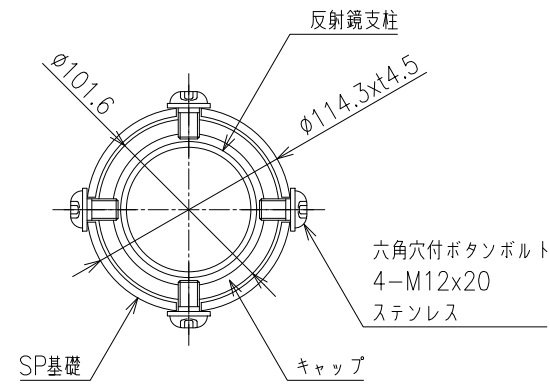

脱着式キャップ s=1/6 (φ76.3支柱用)

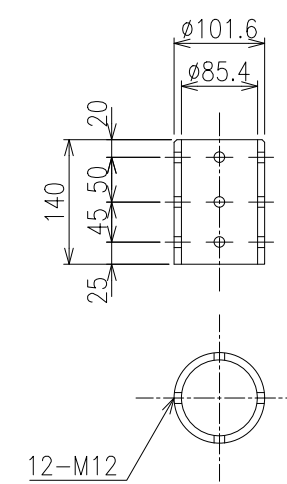

S・P基礎 s=1/5

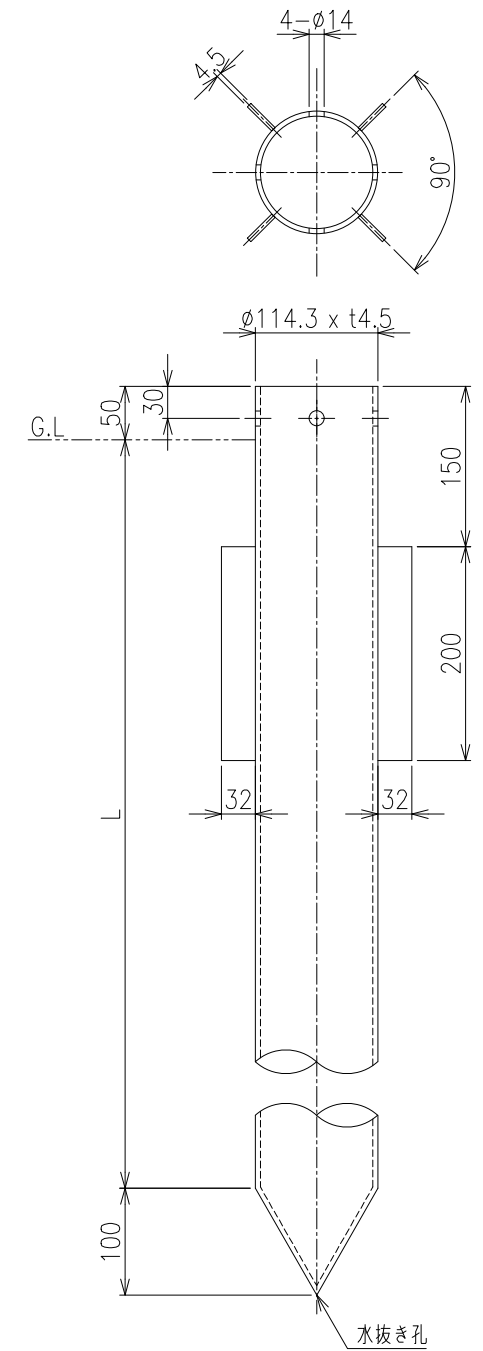

B-B詳細 s=1/3

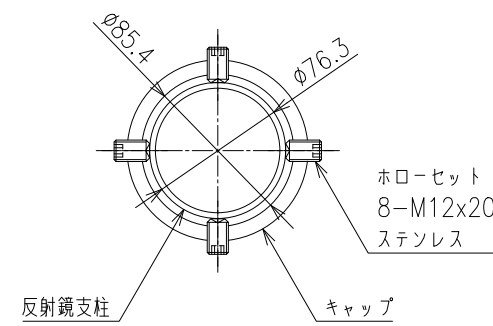

スペーサー s=1/6 (φ76.3支柱用)

